

AC Filter, hohe symmetrische Dämpfung

new



Schutzklasse II Gehäuse UL



Schraubanschluss M4 Gehäuse PK



Litzenanschluss Gehäuse PI

Siehe unten:
[Zulassungen und Konformitäten](#)

Beschreibung

- 1 Stufen Netzfilter mit hoher Dämpfung
- Versionen mit Erdleiterdrossel
- Schutzklasse II Varianten
- 4 Designs
 - N) Excellente symmetrische Dämpfungsgüte
 - P) Hohe symmetrische Dämpfungsgüte
 - Q) Standard Dämpfungsgüte
 - HP) hohe Performance

Alleinstellungsmerkmale

- Exzellente symmetrische Dämpfung
- Kompakt und kostenoptimiert
- Rundum geschlossenes Stahlgehäuse
- Litzenanschlüsse optional

Merkmale

- Kompaktes Filter mit hoher symmetrischer Dämpfung
- Ausgelegt für universelle Industrie-Anwendungen
- Speziell für Anwendungen mit hohen symmetrischen Störungen verursacht durch schaltende Halbleiter
- Geeignet für den Einsatz in Geräten nach IEC/UL 62368-1
- Geeignet für den Einsatz in Medizinalgeräten nach IEC/UL 60601-1 (1 MOOP, 1 MOPP), (Schutzklasse II: 2 MOOP, 2 MOPP)

Weitere Ausführungen auf Anfrage

- Version mit Litzenanschlüssen
- Überspannungsschutz mit Varistor

Referenzen

Weblinks

[PDF-Datenblatt](#), [HTML-Datenblatt](#), [Allgemeine Produktinformation](#), [Zulassungen](#), [Distributor-Stock-Check](#), [Detailanfrage zu Typ](#), [Microsite](#)

Technische Daten

Nenndaten IEC	1 - 60A @ Tu 40 °C / 250 VAC; 50Hz
Nenndaten UL/CSA	1 - 60A @ Tu 40 °C / 125/250 VAC; 60Hz
Ableitstrom	industriell < 1 mA (250V / 60Hz) standard < 0.5 mA (250 V / 60 Hz) medizinal (M5) < 5 µA (250 V / 60 Hz) medizinal (M80) < 80 µA (250 V / 60 Hz)
Spannungsfestigkeit	> 1.7 kVDC zwischen L-N > 2.7 kVDC zwischen L/N-PE Schutzklasse II: >5.6kVDC zwischen L/N-Metallgehäuse Prüfspannung (2 sec)
Zulässige Betriebstemperatur	-40 °C bis 100 °C
Klimakategorie	40/100/21 gemäss IEC 60068-1
Schutzklasse	Geeignet für Geräte der Schutzklasse I oder II gemäss IEC 61140
Klemme	Steckanschluss 6.3 x 0.8 mm Schraubanschluss
Material	Stahl vernickelt

Überspannungsschutz	320 VAC 420 VDC 67 J
Netzfilter	Standard-, Medizinal- und Industrieversion, IEC 60939, UL 1283, CSA C22.2 no. 8 Technische Details
MTBF	> 200'000h gemäss MIL-HB-217 F

Zulassungen und Konformitäten

Detaillierte Informationen zu Zulassungen, Normanforderungen, Verwendungshinweisen und Prüfdetails finden Sie in [Details über Zulassungen](#)

SCHURTER Produkte sind grundsätzlich für den Einsatz im industriellen Umfeld ausgelegt. Sie verfügen über Zulassungen unabhängiger Prüfstellen gemäss nationaler und internationaler Normen.

Produkte mit spezifischen Eigenschaften und Anforderungen wie sie etwa im Bereich Automotive nach IATF 16949, der Medizintechnik gemäss ISO 13485 oder in der Luft- und Raumfahrt gefordert werden, können ausschliesslich mit kundenspezifischen, individuellen Vereinbarungen durch SCHURTER angeboten werden.

Zulassungen



Durch das Zulassungszeichen bescheinigen die Prüfstellen die Einhaltung der sicherheitstechnischen Anforderungen, die an elektronische Produkte gestellt werden.

Zulassung Referenztyp: FMAB NEO

Zulassungslogo	Zertifikat	Zulassungsstelle	Beschreibung
	VDE Zulassungen	VDE	Ausweisnummer: 40041643
	UL Zulassungen	UL	UR Ausweisnummer: E72928

Produktnormen

Produktnormen, welche referenziert werden

Organisation	Design	Norm	Beschreibung
	Ausgelegt gemäss	IEC 60939	Passive Filter für die Unterdrückung von elektromagnetischen Störungen
	Ausgelegt gemäss	UL 1283	Passive Filter für die Unterdrückung von elektromagnetischen Störungen
	Ausgelegt gemäss	CSA C22.2 no. 8	Filter gegen elektromagnetische Störungen (EMI)

Anwendungsnormen

Anwendungsnormen, in welchen die Produkte entsprechend verwendet werden können

Organisation	Design	Norm	Beschreibung
	Geeignet für Anwendungen gemäss	IEC/UL 62368-1	Einrichtungen für Audio/Video-, Informations- und Kommunikationstechnik - Teil 1: Sicherheitsanforderungen

Konformitäten

Das Produkt ist konform mit folgenden Richtlinien

Identifikation	Details	Aussteller	Beschreibung
	CE-Konformitätserklärung	SCHURTER AG	Die CE-Kennzeichnung erklärt, dass das Produkt gemäss der EU-Vordnung 765/2008 den geltenden Anforderungen genügt, die in den Harmonisierungsrechtsvorschriften der Gemeinschaft über ihre Anbringung festgelegt sind.
	UKCA-Konformitätserklärung	SCHURTER AG	Die UKCA-Kennzeichnung erklärt, dass das Produkt gemäss dem Britischen Amendment zur Verordnung (EC) 765/2008 den geltenden Anforderungen genügt.
	RoHS	SCHURTER AG	Richtlinie RoHS 2011/65/EU, Ergänzung (EU) 2015/863
	China RoHS	SCHURTER AG	Das Gesetz SJ/T 11363-2006 (China RoHS) ist seit dem 1. März 2007 in Kraft. Ähnlich wie bei der EU-Richtlinie RoHS.
	REACH	SCHURTER AG	Am 1. Juni 2007 trat die Verordnung (EG) Nr. 1907/2006 zur Registrierung, Bewertung, Zulassung und Beschränkung chemischer Stoffe 1 (kurz: "REACH") in Kraft.

Dimension [mm]

Gehäuse PG mit Steckanschlüssen

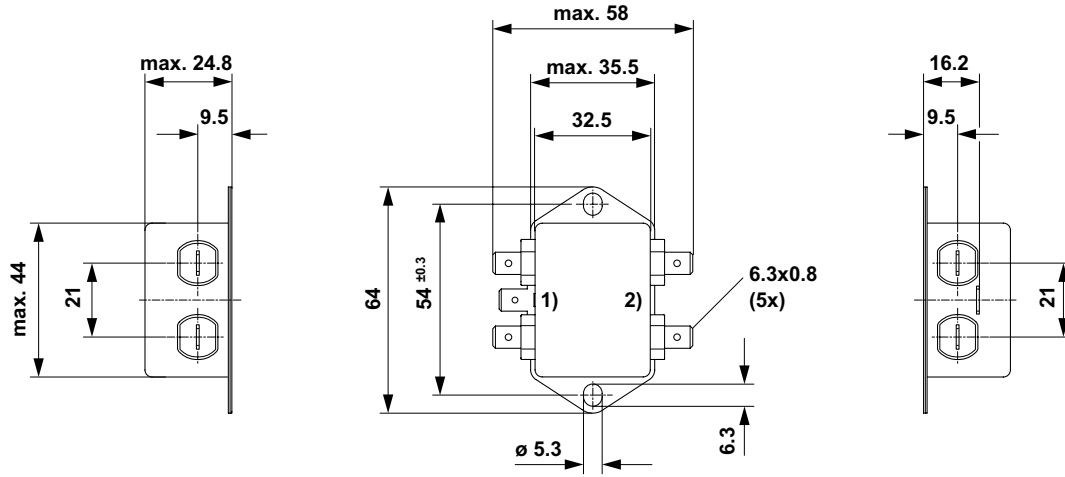

- 1) Netz
- 2) Last

Gehäuse PH mit Steckanschlüssen

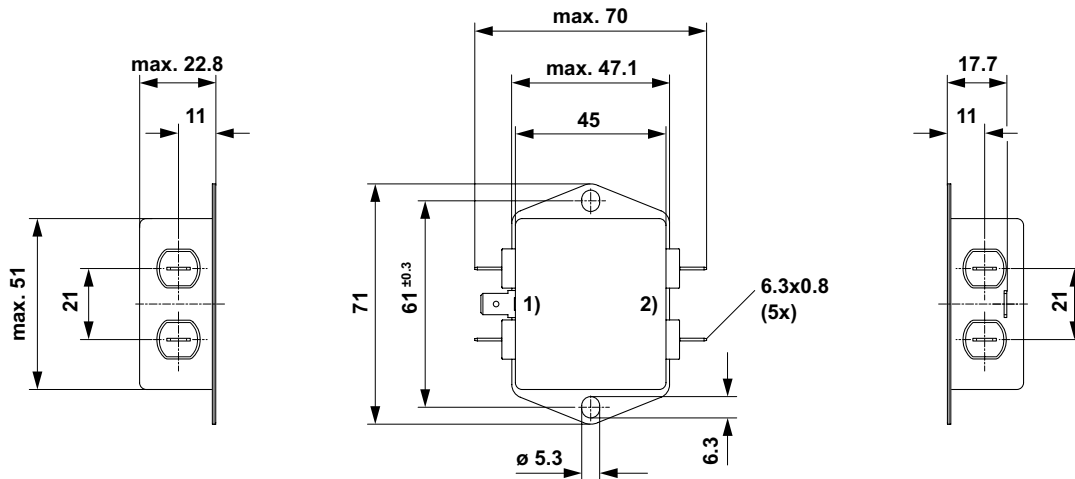

- 1) Netz
- 2) Last

Gehäuse PI mit Steckanschlüssen

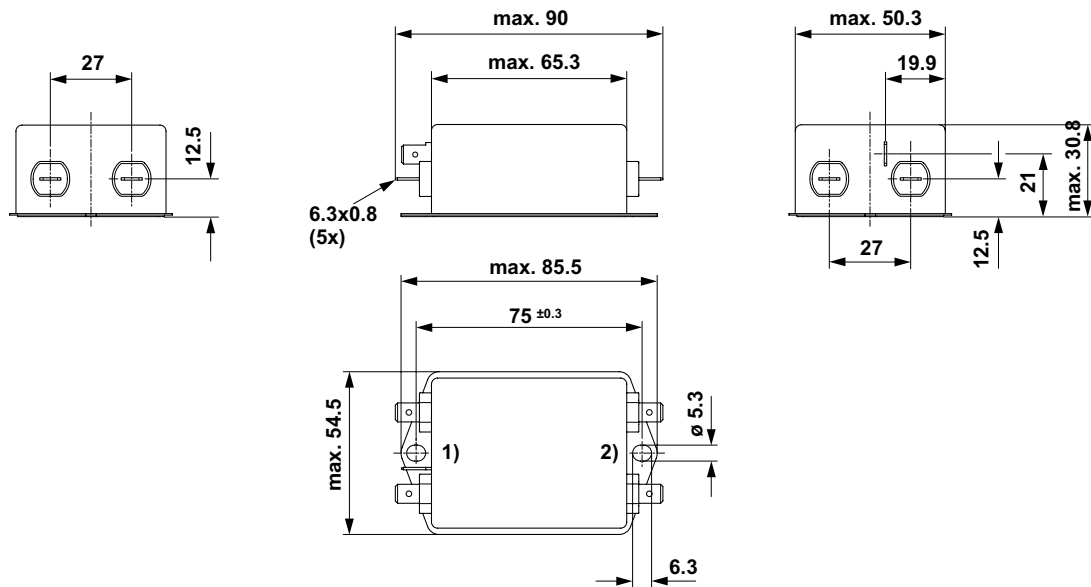

- 1) Netz
- 2) Last

Gehäuse PK mit Steckanschlüssen

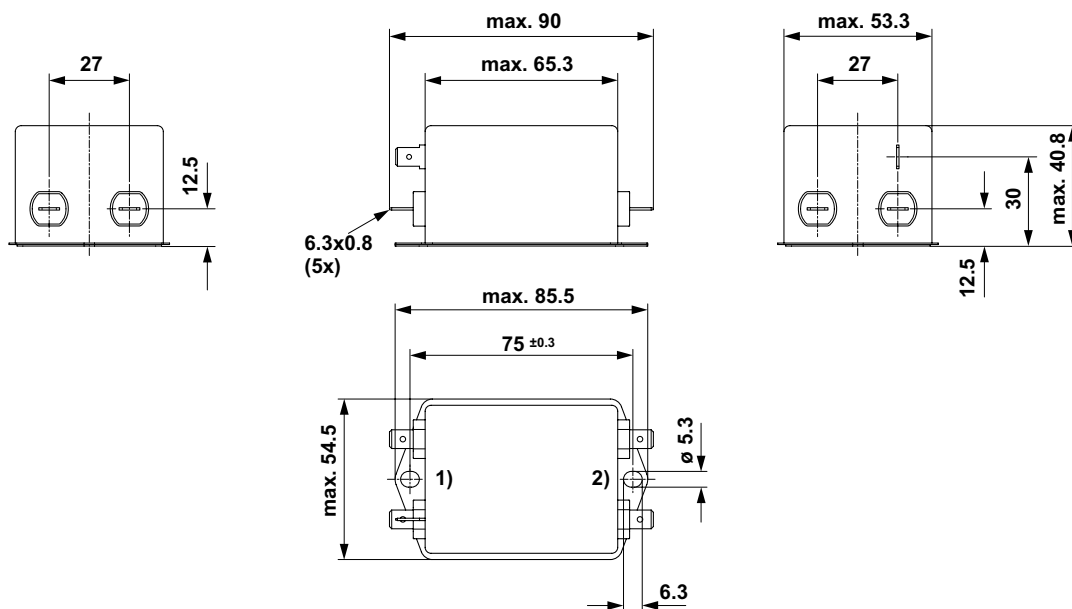

- 1) Netz
- 2) Last

Gehäuse PK mit Schraubanschlüssen

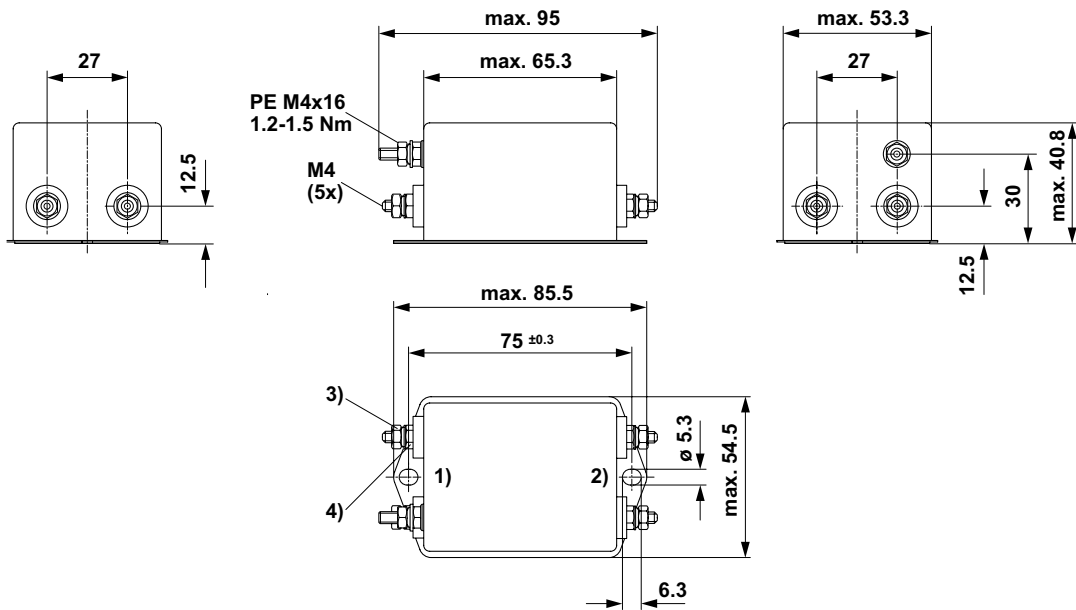

- 1) Netz
- 2) Last
- 3) Anziehdrehmoment 0.8...1 Nm, Kontermutter festhalten
- 4) Kontermutter nicht lösen

Gehäuse QC mit Steckanschlüssen

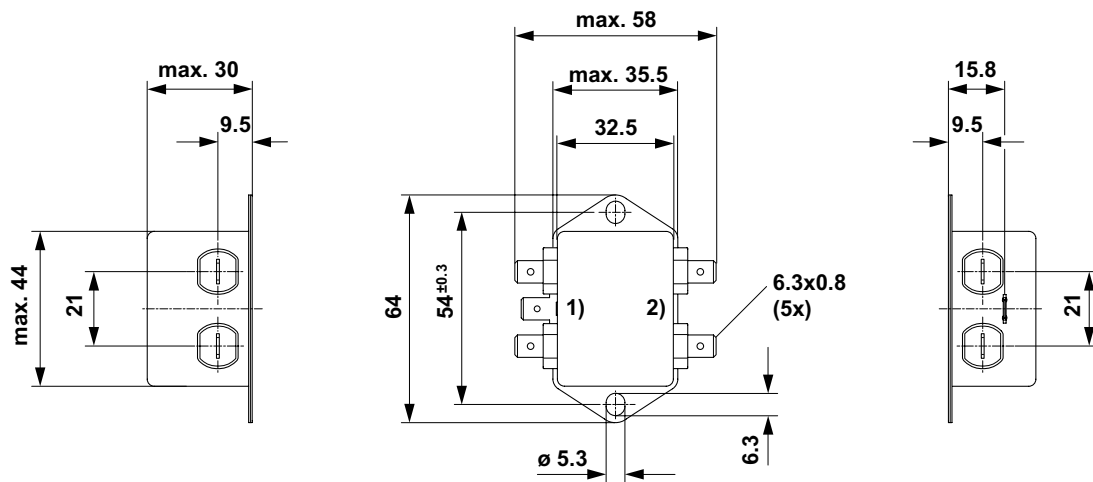

- 1) Netz
- 2) Last

Gehäuse QD mit Steckanschlüssen

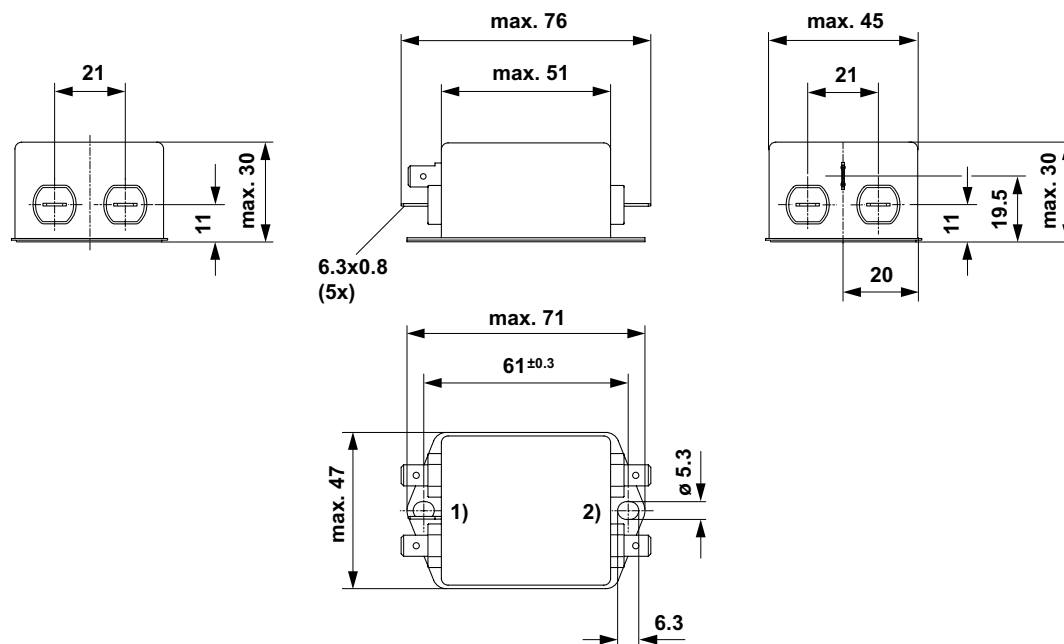

- 1) Netz
- 2) Last

Gehäuse QE mit Schraubanschlüssen

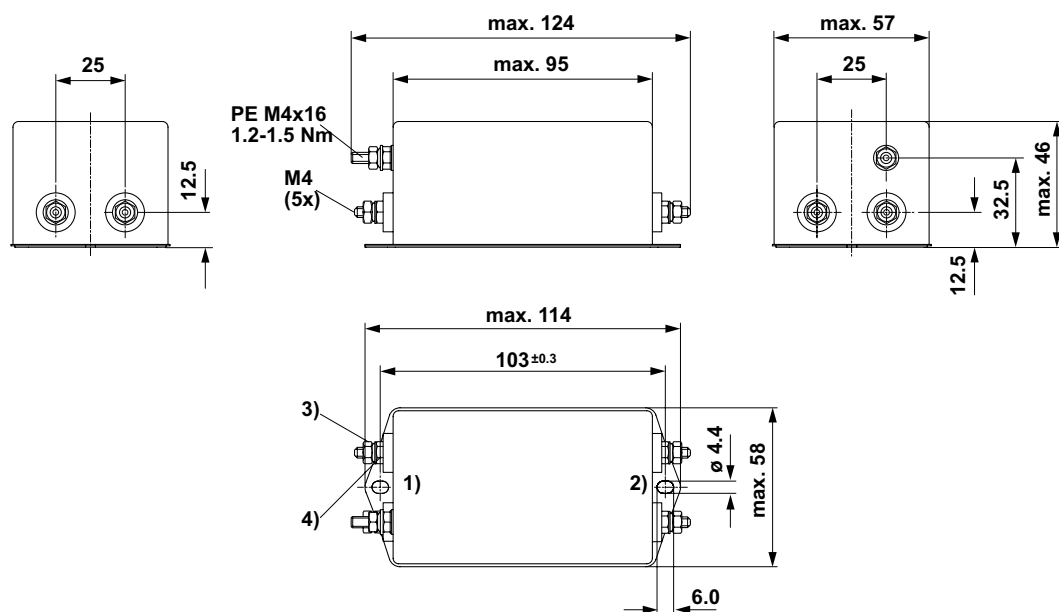

- 1) Netz
- 2) Last
- 3) Anziehdrehmoment 0.8...1 Nm, Kontermutter festhalten
- 4) Kontermutter nicht lösen

Gehäuse QF mit Schraubanschlüssen

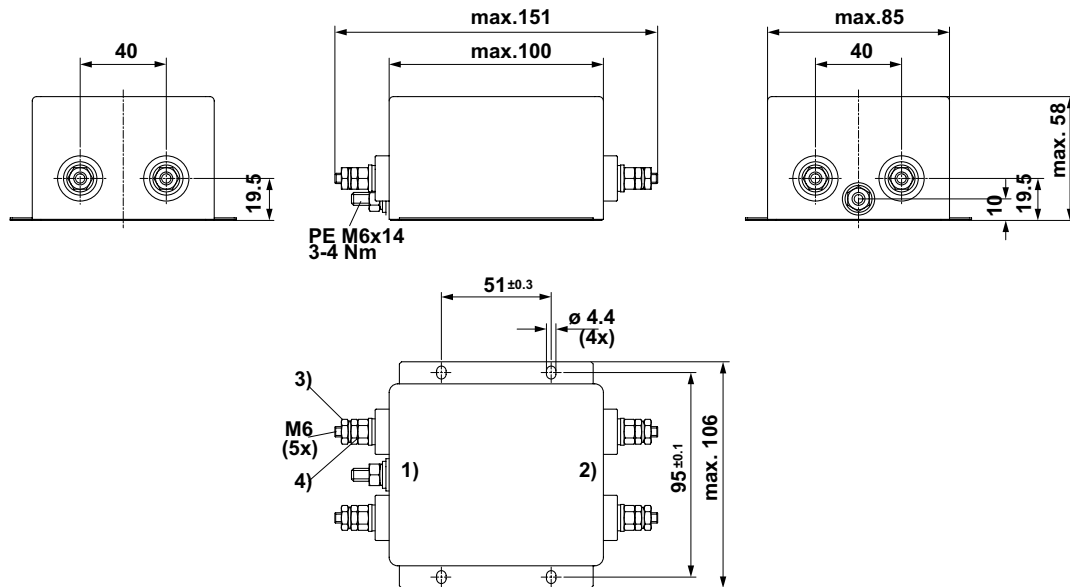

- 1) Netz
- 2) Last
- 3) Anziehdrehmoment 0.8...1 Nm, Kontermutter festhalten
- 4) Kontermutter nicht lösen

Gehäuse mit Litzen

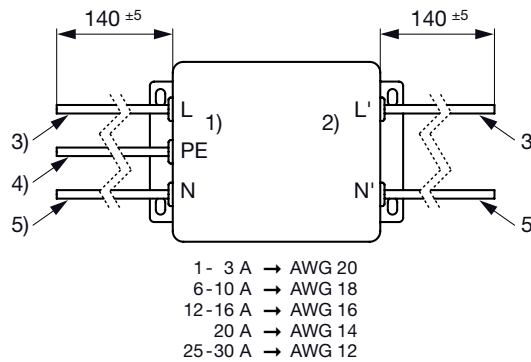

- 1) Netz
- 2) Last
- 3) Braun
- 4) Gelb-Grün
- 5) Blau

Gehäuse UL Schutzklasse II

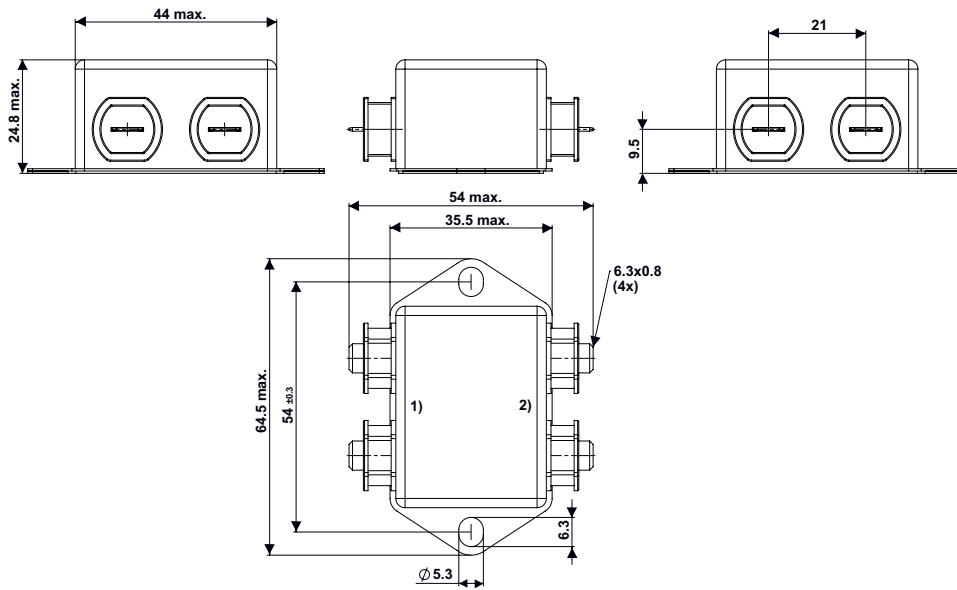

- 1) Netz
- 2) Last

Gehäuse UM Schutzklasse II

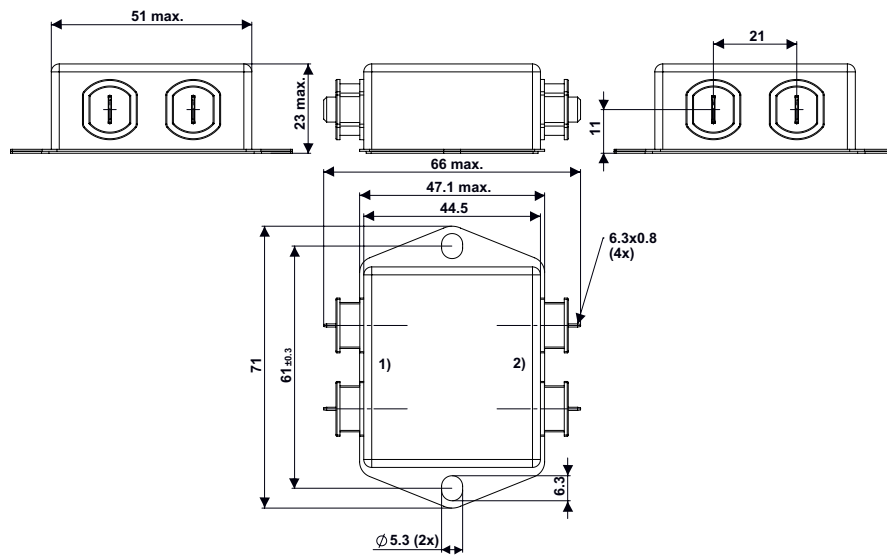

- 1) Netz
- 2) Last

Gehäuse UN Schutzklasse II

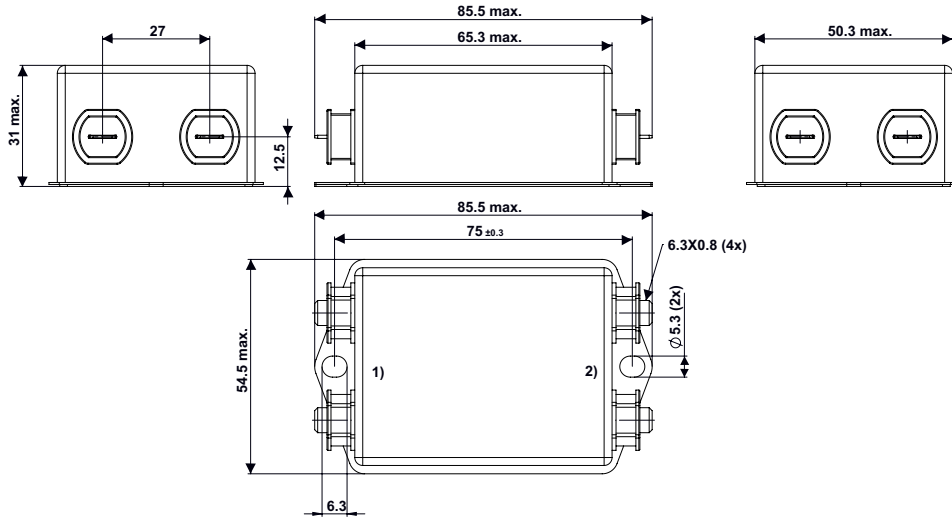

- 1) Netz
- 2) Last

Gehäuse UO Schutzklasse II

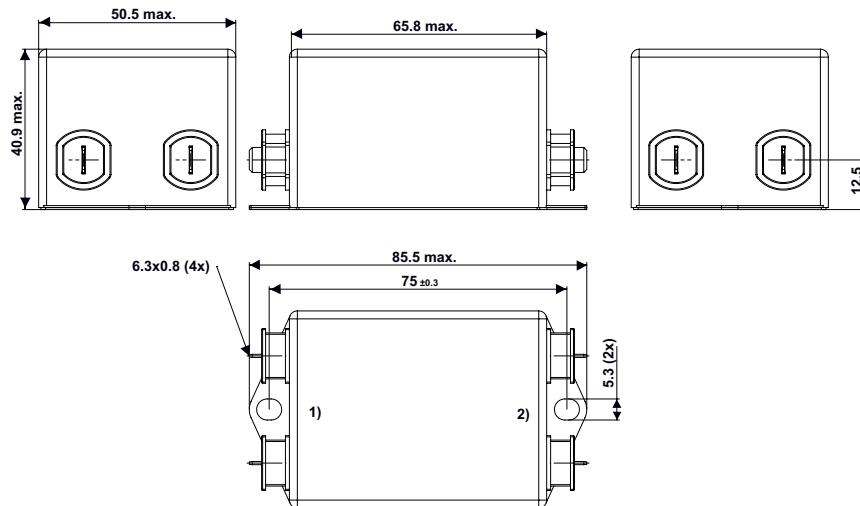

- 1) Netz
- 2) Last

Gehäuse UG mit Erdleiterdrossel

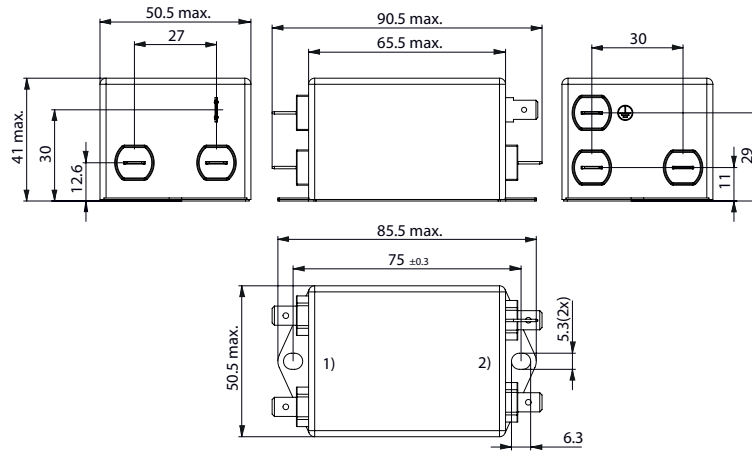

- 1) Netz
- 2) Last

Gehäuse UI mit Erdleiterdrossel

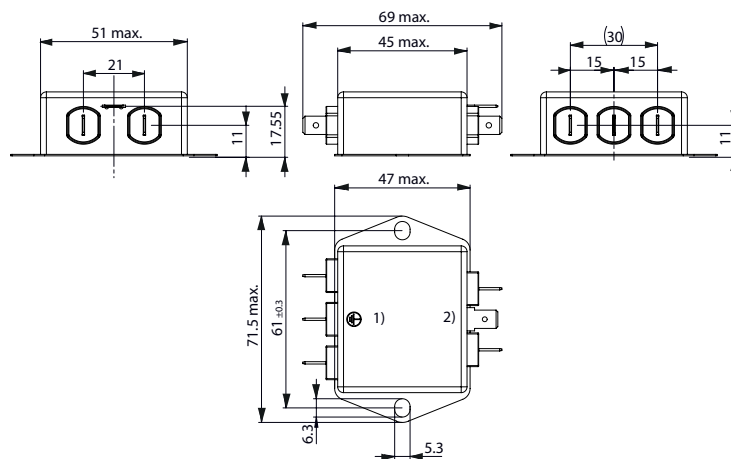

- 1) Netz
- 2) Last

Schaltbilder

Standard Version oder Medizinal M80
 Design N, P

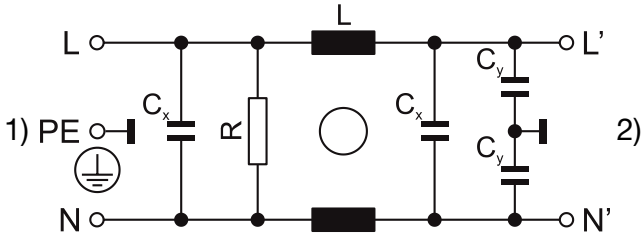

1) Netz
 2) Last

Medizinalversion (M5)
 Design N, P

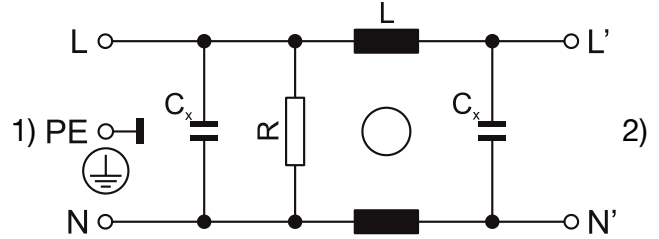

1) Netz
 2) Last

Standard Version oder Medizinal M80
 Design Q

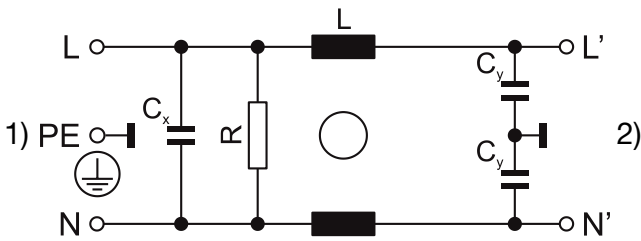

1) Netz
 2) Last

Medizinalversion (M5)
 Design Q

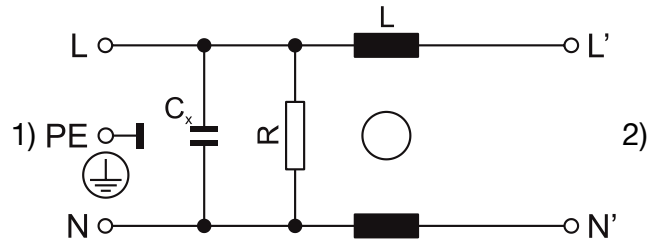

1) Netz
 2) Last

Medizinalversion (M5)
 Schutzklasse II

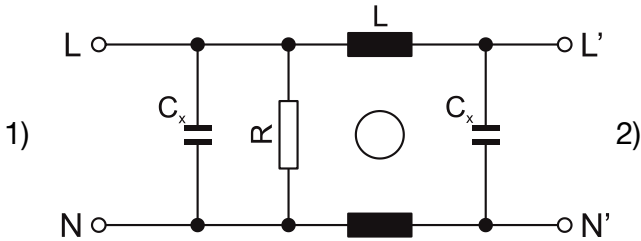

1) Netz
 2) Last

Standard oder Medizinalversion (M80) mit Erdleiterdrossel
 Design N

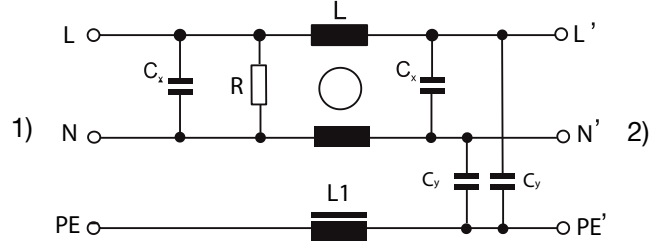

1) Netz
 2) Last

Medizinalversion (M5) mit Erdleiterdrossel
 Design N

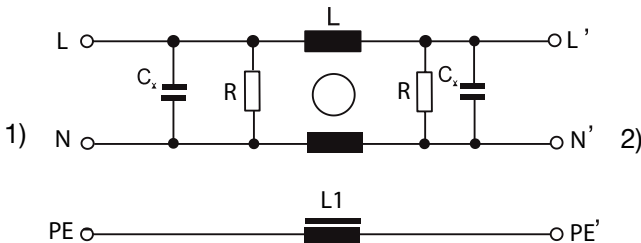

1) Netz
 2) Last

Einfügungsdämpfungen 0.1/100Ω symmetrisch 100/0.1Ω symmetrisch - - - - 50Ω symmetrisch ____ 50Ω asymmetrisch

Standard Version

1 A / Design N

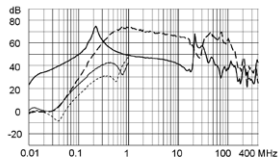

3 A / Design N

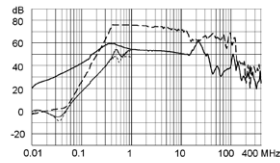

4 A / Design N

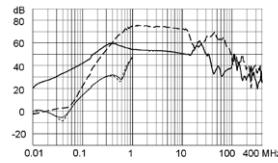

6 A / Design N

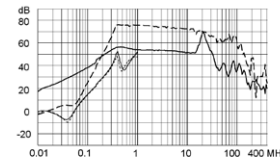

8 A / Design N

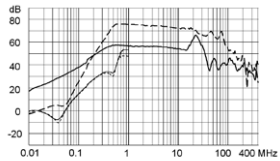

10 A / Design N

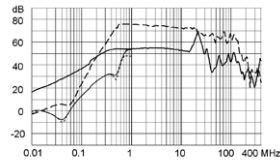

12 A / Design N

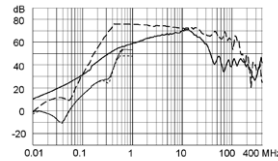

16 A / Design N

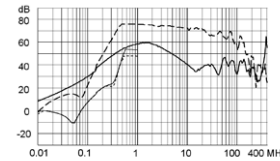

20 A / Design N

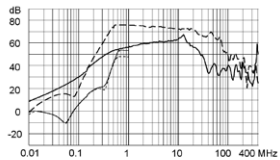

30 A / Design N

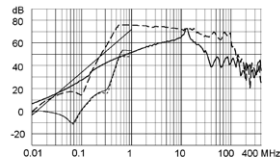

1 A / Design P

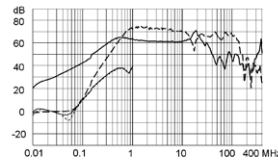

3 A / Design P

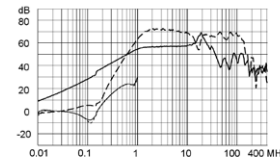

6 A / Design P

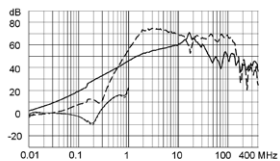

10 A / Design P

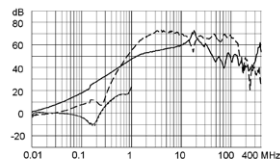

12 A / Design P

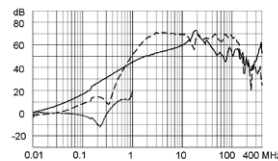

16 A / Design P

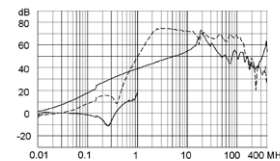

20 A / Design P

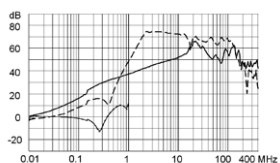

30 A / Design P

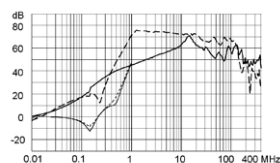

60 A / Design P

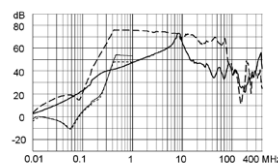

1 A / Design Q

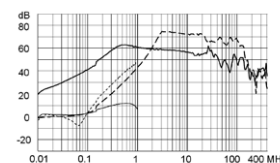

3 A / Design Q

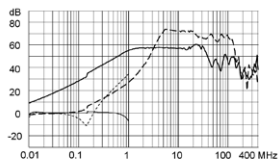

6 A / Design Q

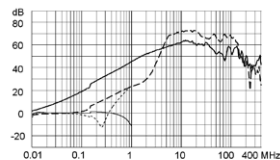

10 A / Design Q

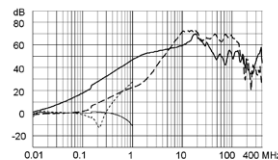

12 A / Design Q

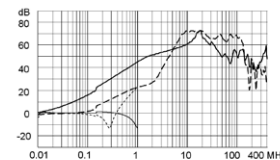

16 A / Design Q

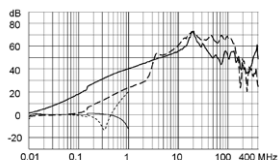

20 A / Design Q

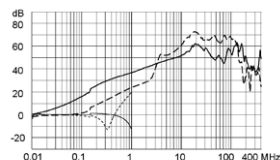

30 A / Design Q

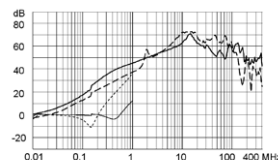

60 A / Design Q

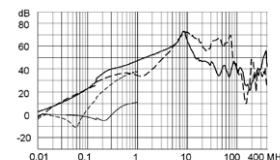

Medizinal Version (M80)

1 A / Design N

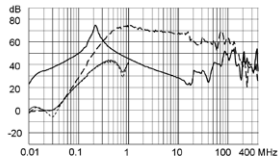

3 A / Design N

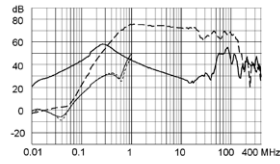

4 A / Design N

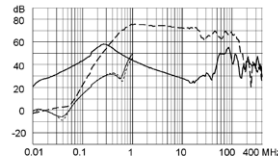

6 A / Design N

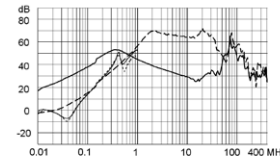

8 A / Design N

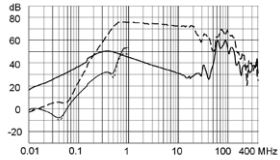

10 A / Design N

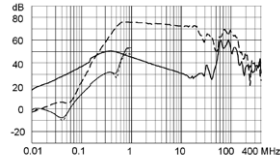

12 A / Design N

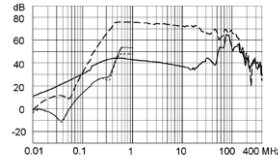

16 A / Design N

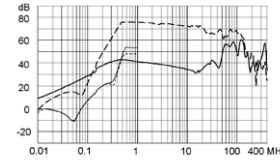

20 A / Design N

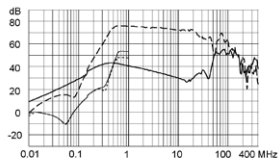

30 A / Design N

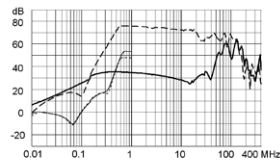

1 A / Design P

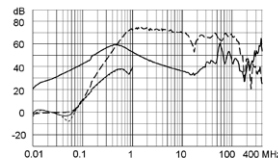

3 A / Design P

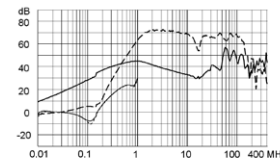

6 A / Design P

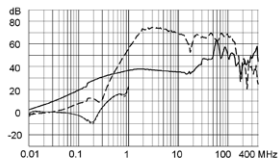

10 A / Design P

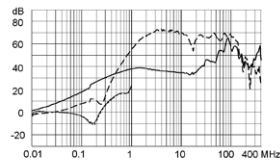

12 A / Design P

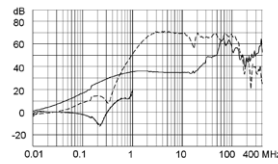

16 A / Design P

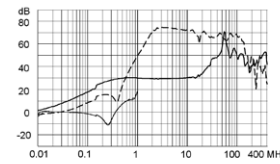

20 A / Design P

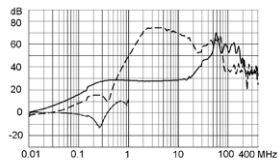

30 A / Design P

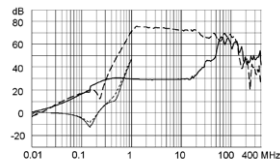

60 A / Design P

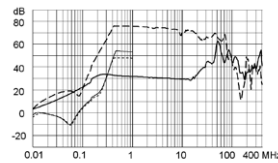

1 A / Design Q

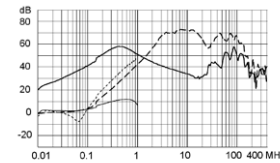

3 A / Design Q

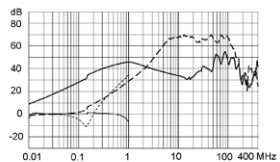

6 A / Design Q

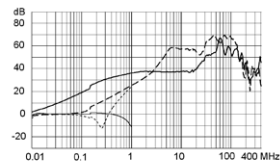

10 A / Design Q

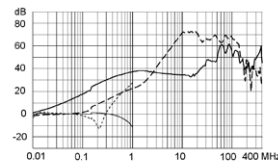

12 A / Design Q

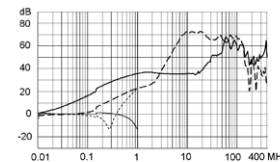

16 A / Design Q

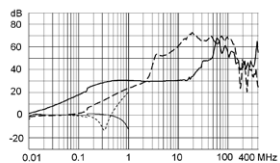

20 A / Design Q

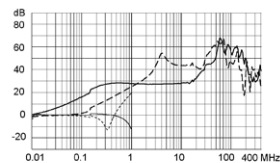

30 A / Design Q

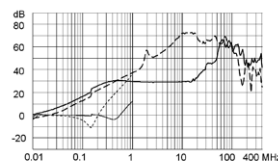

60 A / Design Q

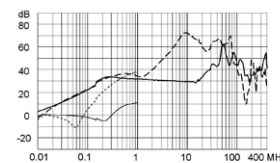

Standard mit Erdleiterdrossel

1 A / Design N

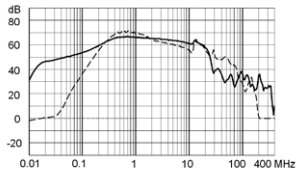

3 A / Design N

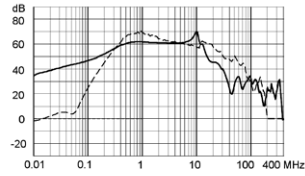

4 A / Design N

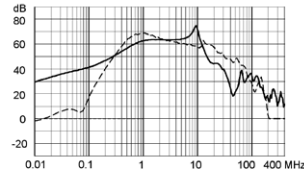

6 A / Design N

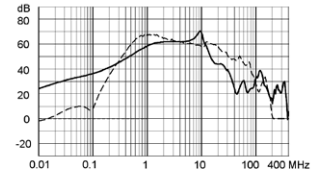

8 A / Design N

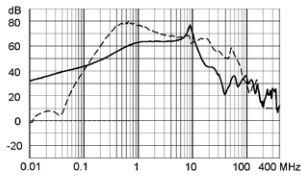

10 A / Design N

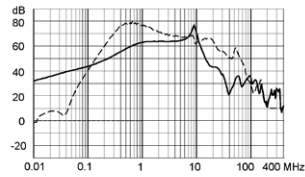

12 A / Design N

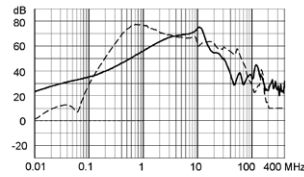

16 A / Design N

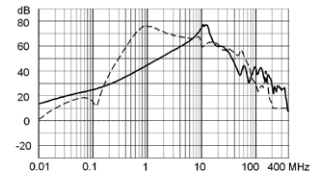

20 A / Design N

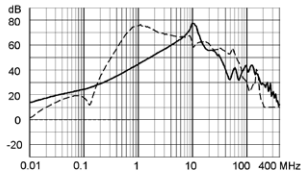

Medizinal (M5) mit Erdleiterdrossel

1 A / Design N

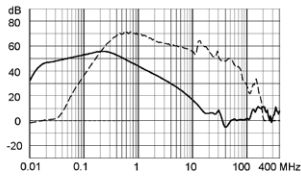

3 A / Design N

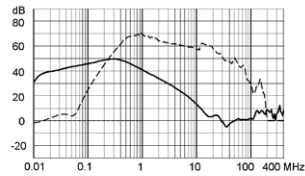

4 A / Design N

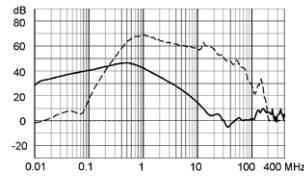

6 A / Design N

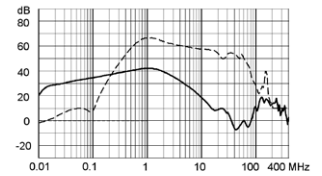

8 A / Design N

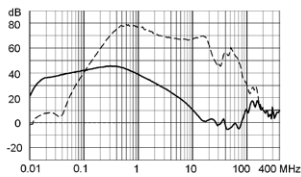

10 A / Design N

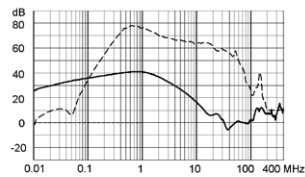

12 A / Design N

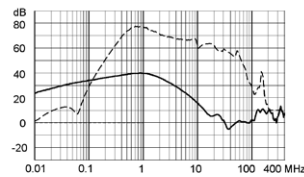

16 A / Design N

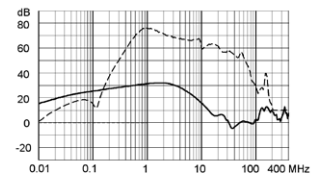

20 A / Design N

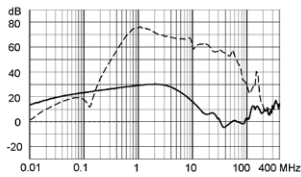

Medizinal (M80) mit Erdleiterdrossel

1 A / Design N

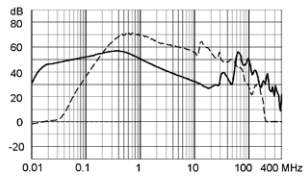

3 A / Design N

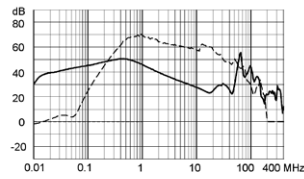

4 A / Design N

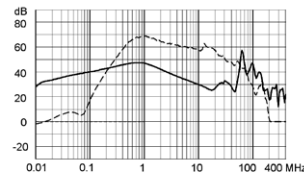

6 A / Design N

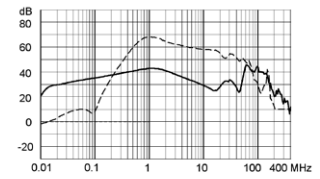

8 A / Design N

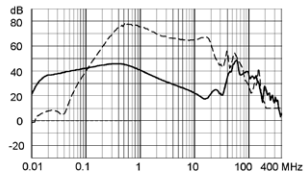

10 A / Design N

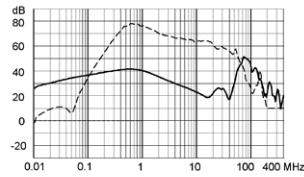

12 A / Design N

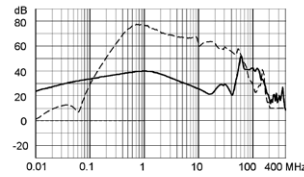

16 A / Design N

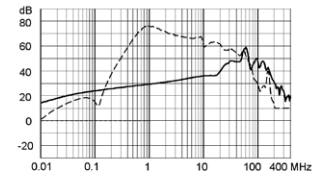

20 A / Design N

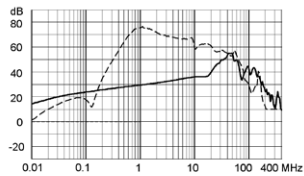

Standard HP

1 A

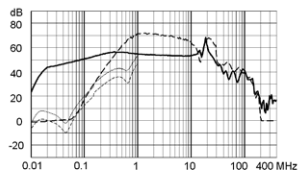

3 A

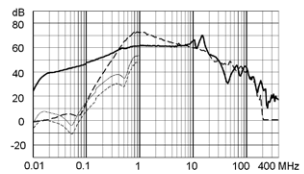

4 A

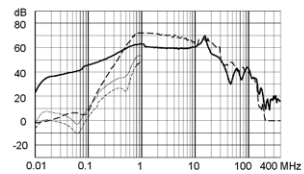

6 A

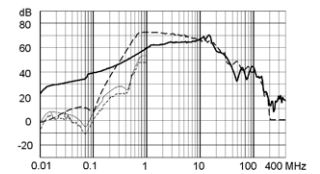

8 A

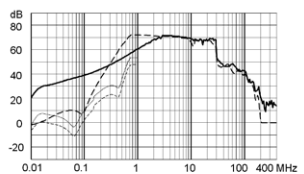

10 A

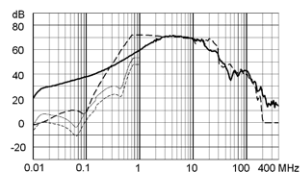

12 A

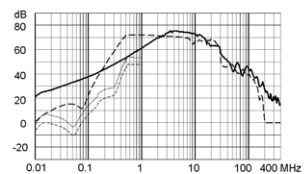

16 A

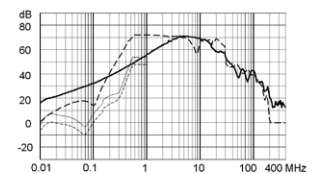

20 A

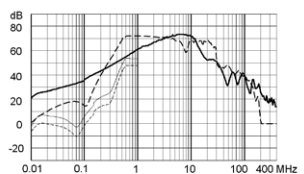

30 A

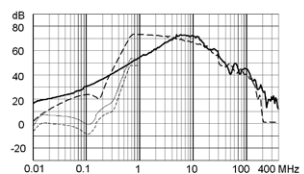

Medizinal (M5) HP

1 A

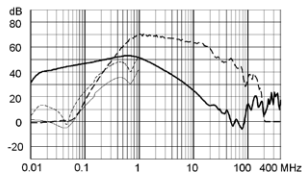

3 A

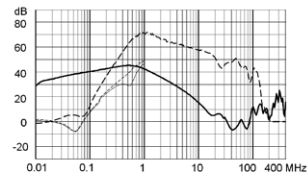

4 A

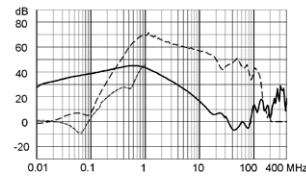

6 A

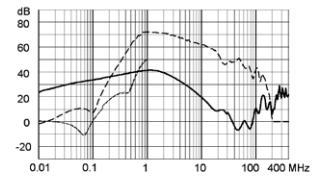

8 A

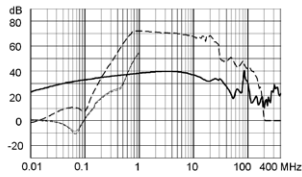

10 A

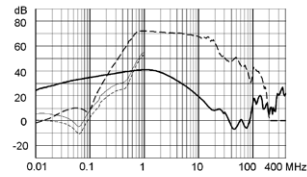

12 A

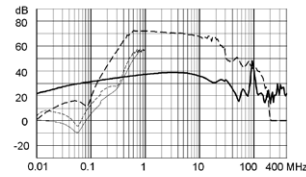

16 A

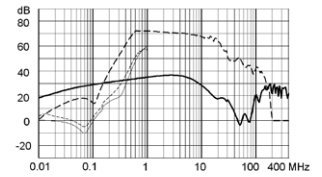

20 A

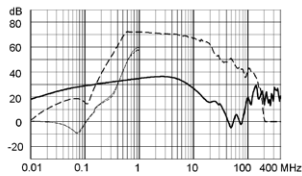

30 A

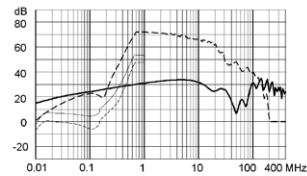

Medizinal (M80) HP

1 A

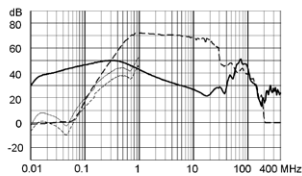

3 A

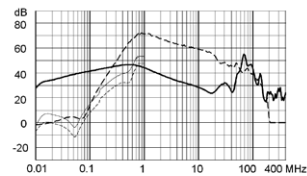

4 A

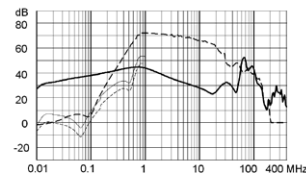

6 A

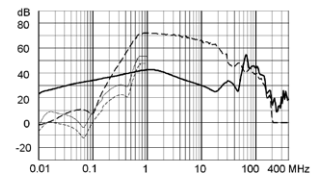

8 A

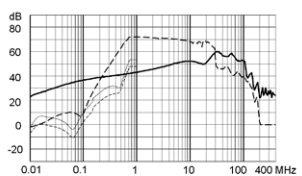

10 A

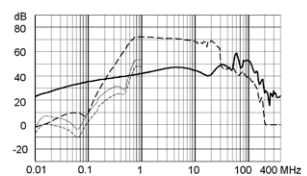

12 A

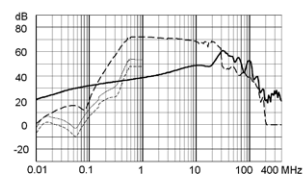

16 A

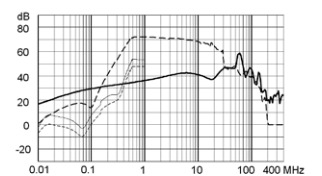

20 A

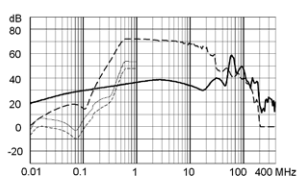

30 A

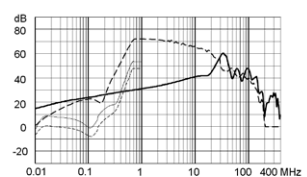

Alle Varianten

Nennstrom	Filter-Typ	Klemme	Design	Schutzklasse	Ableitstrom	Ri	Verlustleistung	Überspannungsschutz	Gewicht	Gehäuse	Verpackung	Bestell-Nummer
[A]					[mA]	[mΩ]	[W]		[g]		[ST]	
1	Standardversion	QC 6.3 x 0.8 mm	N	I	0.5	475	1	-	72g	PG	15	5500.2630.01
1	Standardversion	QC 6.3 x 0.8 mm	N	I	0.5	475	1	VDR	72g	PG	15	5500.2630.21
1	Standardversion	QC 6.3 x 0.8 mm	P	I	0.5	320	0.65	-	80g	QC	15	5500.2640.01
1	Standardversion	QC 6.3 x 0.8 mm	Q	I	0.5	320	0.65	-	66g	PG	15	5500.2650.01
3	Standardversion	QC 6.3 x 0.8 mm	N	I	0.5	83	1.5	-	104g	PH	15	5500.2631.01
3	Standardversion	QC 6.3 x 0.8 mm	N	I	0.5	83	1.5	VDR	104g	PH	15	5500.2631.21
3	Standardversion	QC 6.3 x 0.8 mm	P	I	0.5	36	0.65	-	81g	QC	15	5500.2641.01
3	Standardversion	QC 6.3 x 0.8 mm	Q	I	0.5	36	0.65	-	70g	PG	15	5500.2651.01
4	Standardversion	QC 6.3 x 0.8 mm	N	I	0.5	53	1.7	-	108g	PH	15	5500.2632.01
4	Standardversion	QC 6.3 x 0.8 mm	N	I	0.5	53	1.7	VDR	108g	PH	15	5500.2632.21
6	Standardversion	QC 6.3 x 0.8 mm	N	I	0.5	32.5	2.4	-	109g	PH	15	5500.2633.01
6	Standardversion	QC 6.3 x 0.8 mm	N	I	0.5	32.5	2.4	VDR	109g	PH	15	5500.2633.21
6	Standardversion	QC 6.3 x 0.8 mm	P	I	0.5	12	0.86	-	80g	QC	15	5500.2642.01
6	Standardversion	QC 6.3 x 0.8 mm	Q	I	0.5	12	0.86	-	100g	PG	15	5500.2652.01
8	Standardversion	QC 6.3 x 0.8 mm	N	I	0.5	29.2	3.8	-	190g	PI	10	5500.2634.01
8	Standardversion	QC 6.3 x 0.8 mm	N	I	0.5	29.2	3.8	VDR	190g	PI	10	5500.2634.21
10	Standardversion	QC 6.3 x 0.8 mm	P	I	0.5	5	1	-	87g	QC	15	5500.2643.01
10	Standardversion	QC 6.3 x 0.8 mm	Q	I	0.5	5	1	-	90g	QC	15	5500.2653.01
12	Standardversion	QC 6.3 x 0.8 mm	P	I	0.5	4	1.2	-	92g	QC	15	5500.2644.01
12	Standardversion	QC 6.3 x 0.8 mm	Q	I	0.5	4	1.2	-	90g	QC	15	5500.2654.01
16	Standardversion	QC 6.3 x 0.8 mm	P	I	0.5	2	1	-	138g	QD	15	5500.2645.01
16	Standardversion	QC 6.3 x 0.8 mm	Q	I	0.5	2	1	-	136g	QD	15	5500.2655.01
20	Standardversion	QC 6.3 x 0.8 mm	P	I	0.5	1.9	1.5	-	206g	PI	10	5500.2646.01
20	Standardversion	QC 6.3 x 0.8 mm	Q	I	0.5	1.9	1.5	-	204g	PI	10	5500.2656.01
1	Standardversion mit Erdleiterdrossel	QC 6.3 x 0.8 mm	N	I	1.57	390	1	-	100g	UI	15	3-137-000
3	Standardversion mit Erdleiterdrossel	QC 6.3 x 0.8 mm	N	I	1.57	62	1.2	-	104g	UI	15	3-137-001
4	Standardversion mit Erdleiterdrossel	QC 6.3 x 0.8 mm	N	I	1.57	36	1.3	-	108g	UI	15	3-137-002
6	Standardversion mit Erdleiterdrossel	QC 6.3 x 0.8 mm	N	I	1.57	21	1.6	-	110g	UI	15	3-137-003
8	Standardversion mit Erdleiterdrossel	QC 6.3 x 0.8 mm	N	I	1.57	29	3.8	-	280g	UG	10	3-137-004
10	Standardversion mit Erdleiterdrossel	QC 6.3 x 0.8 mm	N	I	1.57	13	2.6	-	295g	UG	10	3-137-005
12	Standardversion mit Erdleiterdrossel	QC 6.3 x 0.8 mm	N	I	1.57	9	2.6	-	300g	UG	10	3-137-006
16	Standardversion mit Erdleiterdrossel	QC 6.3 x 0.8 mm	N	I	1.57	3.3	2.8	-	310g	UG	10	3-137-007
20	Standardversion mit Erdleiterdrossel	QC 6.3 x 0.8 mm	N	I	1.57	1	3.5	-	322g	UG	10	3-137-008
1	Standardversion HP	QC 6.3 x 0.8 mm	N	I	0.74	286	0.57	-	72g	PG	15	3-143-596
3	Standardversion HP	QC 6.3 x 0.8 mm	N	I	1.07	55	0.99	-	104g	PH	15	3-143-597
4	Standardversion HP	QC 6.3 x 0.8 mm	N	I	1.07	33	1.06	-	108g	PH	15	3-143-598
6	Standardversion HP	QC 6.3 x 0.8 mm	N	I	1.07	20.5	1.48	-	109g	PH	15	3-143-599
8	Standardversion HP	QC 6.3 x 0.8 mm	N	I	1.57	21.6	2.76	-	190g	PI	10	3-143-600
10	Standardversion HP	QC 6.3 x 0.8 mm	N	I	1.57	15.5	3.1	-	200g	PI	10	3-143-601
12	Standardversion HP	QC 6.3 x 0.8 mm	N	I	1.57	11	3.17	-	201g	PI	10	3-143-602
16	Standardversion HP	QC 6.3 x 0.8 mm	N	I	2.36	6.9	3.53	-	308g	UB	10	3-143-603
20	Standardversion HP	QC 6.3 x 0.8 mm	N	I	2.36	6.2	4.96	-	322g	PK	10	3-143-604
30	Standardversion HP	QC 6.3 x 0.8 mm	N	I	2.36	2.9	5.2	-	355g	PK	10	3-143-605
60	Industrieversion	Schraubanschluss M6	P	I	1	1	7.2	-	1220g	QF	1	5500.2648.03
60	Industrieversion	Schraubanschluss M6	Q	I	1	1	7.2	-	1220g	QF	1	5500.2658.03

Nennstrom [A]	Filter-Typ	Klemme	Design	Schutz- klasse	Ableit- strom [mA]	Ri [mΩ]	Verlust- leistung [W]	Überspan- nungsschutz	Gewicht [g]	Gehäuse	Verpa- ckung [ST]	Bestell-Nummer
10	Industrieversion	QC 6.3 x 0.8 mm	N	I	1	22.8	4.6	-	200g	PI	10	5500.2635.01
10	Industrieversion	QC 6.3 x 0.8 mm	N	I	1	22.8	4.6	VDR	200g	PI	10	5500.2635.21
12	Industrieversion	QC 6.3 x 0.8 mm	N	I	1	13.2	3.8	-	201g	PI	10	5500.2636.01
12	Industrieversion	QC 6.3 x 0.8 mm	N	I	1	13.2	3.8	VDR	201g	PI	10	5500.2636.21
16	Industrieversion	QC 6.3 x 0.8 mm	N	I	1	7.2	3.7	-	308g	PK	10	5500.2637.01
16	Industrieversion	QC 6.3 x 0.8 mm	N	I	1	7.2	3.7	VDR	308g	PK	10	5500.2637.21
20	Industrieversion	QC 6.3 x 0.8 mm	N	I	1	6.0	4.8	-	322g	PK	10	5500.2638.01
20	Industrieversion	QC 6.3 x 0.8 mm	N	I	1	6.0	4.8	VDR	322g	PK	10	5500.2638.21
30	Industrieversion	Schraubanschluss M4	N	I	1	2.9	5.2	-	355g	PK	10	5500.2639.03
30	Industrieversion	Schraubanschluss M4	P	I	1	1	1.8	-	450g	QE	5	5500.2647.03
30	Industrieversion	Schraubanschluss M4	Q	I	1	1	1.8	-	450g	QE	5	5500.2657.03
1	Medizinalversion (M5) mit Erdleiter- drossel	QC 6.3 x 0.8 mm	N	I	0.005	390	1	-	100g	UI	15	3-137-009
3	Medizinalversion (M5) mit Erdleiter- drossel	QC 6.3 x 0.8 mm	N	I	0.005	62	1.2	-	104g	UI	15	3-137-010
4	Medizinalversion (M5) mit Erdleiter- drossel	QC 6.3 x 0.8 mm	N	I	0.005	36	1.3	-	108g	UI	15	3-137-011
6	Medizinalversion (M5) mit Erdleiter- drossel	QC 6.3 x 0.8 mm	N	I	0.005	21	1.6	-	110g	UI	15	3-137-012
8	Medizinalversion (M5) mit Erdleiter- drossel	QC 6.3 x 0.8 mm	N	I	0.005	29	3.8	-	280g	UG	10	3-137-013
10	Medizinalversion (M5) mit Erdleiter- drossel	QC 6.3 x 0.8 mm	N	I	0.005	13	2.6	-	295g	UG	10	3-137-014
12	Medizinalversion (M5) mit Erdleiter- drossel	QC 6.3 x 0.8 mm	N	I	0.005	9	2.6	-	300g	UG	10	3-137-015
16	Medizinalversion (M5) mit Erdleiter- drossel	QC 6.3 x 0.8 mm	N	I	0.005	3.3	2.8	-	310g	UG	10	3-137-016
20	Medizinalversion (M5) mit Erdleiter- drossel	QC 6.3 x 0.8 mm	N	I	0.005	1	3.5	-	322g	UG	10	3-137-017
1	Medizinalversion (M80) mit Erdleiter- drossel	QC 6.3 x 0.8 mm	N	I	0.08	390	1	-	100g	UI	15	3-137-018
3	Medizinalversion (M80) mit Erdleiter- drossel	QC 6.3 x 0.8 mm	N	I	0.08	62	1.2	-	104g	UI	15	3-137-019
4	Medizinalversion (M80) mit Erdleiter- drossel	QC 6.3 x 0.8 mm	N	I	0.08	36	1.3	-	108g	UI	15	3-137-020
6	Medizinalversion (M80) mit Erdleiter- drossel	QC 6.3 x 0.8 mm	N	I	0.08	21	1.6	-	110g	UI	15	3-137-021
8	Medizinalversion (M80) mit Erdleiter- drossel	QC 6.3 x 0.8 mm	N	I	0.08	29	3.8	-	280g	UG	10	3-137-022
10	Medizinalversion (M80) mit Erdleiter- drossel	QC 6.3 x 0.8 mm	N	I	0.08	13	2.6	-	295g	UG	10	3-137-023
12	Medizinalversion (M80) mit Erdleiter- drossel	QC 6.3 x 0.8 mm	N	I	0.08	9	2.6	-	300g	UG	10	3-137-024
16	Medizinalversion (M80) mit Erdleiter- drossel	QC 6.3 x 0.8 mm	N	I	0.08	3.3	2.8	-	310g	UG	10	3-137-025
20	Medizinalversion (M80) mit Erdleiter- drossel	QC 6.3 x 0.8 mm	N	I	0.08	1	3.5	-	322g	UG	10	3-137-026
60	Medizinal (M5)	Schraubanschluss M6	P	I	0.005	1	7.2	-	1220g	QF	1	5500.2648.06

Nennstrom	Filter-Typ	Klemme	Design	Schutzklasse	Ableitstrom	Ri	Verlustleistung	Überspannungsschutz	Gewicht	Gehäuse	Verpackung	Bestell-Nummer
[A]					[mA]	[mΩ]	[W]		[g]		[ST]	
60	Medizinal (M5)	Schraubanschluss M6	Q	I	0.005	1	7.2	-	1220g	QF	1	5500.2658.06
1	Medizinal (M5)	QC 6.3 x 0.8 mm	N	II	0.005	540	1.08	-	72g	UL	15	3-134-821
1	Medizinal (M5)	QC 6.3 x 0.8 mm	N	I	0.005	475	1	-	72g	PG	15	5500.2630.04
1	Medizinal (M5)	QC 6.3 x 0.8 mm	P	I	0.005	320	0.65	-	80g	QC	15	5500.2640.04
1	Medizinal (M5)	QC 6.3 x 0.8 mm	Q	I	0.005	320	0.65	-	66g	PG	15	5500.2650.04
3	Medizinal (M5)	QC 6.3 x 0.8 mm	N	II	0.005	82	1.48	-	104g	UM	15	3-134-822
3	Medizinal (M5)	QC 6.3 x 0.8 mm	N	I	0.005	83	1.5	-	104g	PH	15	5500.2631.04
3	Medizinal (M5)	QC 6.3 x 0.8 mm	P	I	0.005	36	0.65	-	81g	QC	15	5500.2641.04
3	Medizinal (M5)	QC 6.3 x 0.8 mm	Q	I	0.005	36	0.65	-	70g	PG	15	5500.2651.04
4	Medizinal (M5)	QC 6.3 x 0.8 mm	N	II	0.005	50	1.6	-	108g	UM	15	3-134-823
4	Medizinal (M5)	QC 6.3 x 0.8 mm	N	I	0.005	53	1.7	-	108g	PH	15	5500.2632.04
6	Medizinal (M5)	QC 6.3 x 0.8 mm	N	II	0.005	32	2.3	-	110g	UM	15	3-134-824
6	Medizinal (M5)	QC 6.3 x 0.8 mm	N	I	0.005	32.5	2.4	-	109g	PH	15	5500.2633.04
6	Medizinal (M5)	QC 6.3 x 0.8 mm	P	I	0.005	12	0.86	-	80g	QC	15	5500.2642.04
6	Medizinal (M5)	QC 6.3 x 0.8 mm	Q	I	0.005	12	0.86	-	100g	PG	15	5500.2652.04
8	Medizinal (M5)	QC 6.3 x 0.8 mm	N	II	0.005	29	3.71	-	188g	UN	10	3-134-825
8	Medizinal (M5)	QC 6.3 x 0.8 mm	N	I	0.005	29.2	3.8	-	190g	PI	10	5500.2634.04
10	Medizinal (M5)	QC 6.3 x 0.8 mm	N	II	0.005	19	3.8	-	200g	UN	10	3-134-826
10	Medizinal (M5)	QC 6.3 x 0.8 mm	N	I	0.005	22.8	4.6	-	200g	PI	10	5500.2635.04
10	Medizinal (M5)	QC 6.3 x 0.8 mm	P	I	0.005	5	1	-	87g	QC	15	5500.2643.04
10	Medizinal (M5)	QC 6.3 x 0.8 mm	Q	I	0.005	5	1	-	90g	QC	15	5500.2653.04
12	Medizinal (M5)	QC 6.3 x 0.8 mm	N	II	0.005	11	3.17	-	200g	UN	10	3-134-827
12	Medizinal (M5)	QC 6.3 x 0.8 mm	N	I	0.005	13.2	3.8	-	201g	PI	10	5500.2636.04
12	Medizinal (M5)	QC 6.3 x 0.8 mm	P	I	0.005	4	1.2	-	92g	QC	15	5500.2644.04
12	Medizinal (M5)	QC 6.3 x 0.8 mm	Q	I	0.005	4	1.2	-	90g	QC	15	5500.2654.04
16	Medizinal (M5)	QC 6.3 x 0.8 mm	N	II	0.005	6	3.07	-	310g	UO	10	3-134-828
16	Medizinal (M5)	QC 6.3 x 0.8 mm	N	I	0.005	7.2	3.7	-	308g	PK	10	5500.2637.04
16	Medizinal (M5)	QC 6.3 x 0.8 mm	P	I	0.005	2	1	-	138g	QD	15	5500.2645.04
16	Medizinal (M5)	QC 6.3 x 0.8 mm	Q	I	0.005	2	1	-	136g	QD	15	5500.2655.04
20	Medizinal (M5)	QC 6.3 x 0.8 mm	N	II	0.005	5	4	-	322g	UO	10	3-134-829
20	Medizinal (M5)	QC 6.3 x 0.8 mm	N	I	0.005	6	4.8	-	322g	PK	10	5500.2638.04
20	Medizinal (M5)	QC 6.3 x 0.8 mm	P	I	0.005	1.9	1.5	-	206g	PI	10	5500.2646.04
20	Medizinal (M5)	QC 6.3 x 0.8 mm	Q	I	0.005	1.9	1.5	-	204g	PI	10	5500.2656.04
30	Medizinal (M5)	Schraubanschluss M4	N	I	0.005	2.9	5.2	-	355g	PK	10	5500.2639.06
30	Medizinal (M5)	Schraubanschluss M4	P	I	0.005	1	1.8	-	450g	QE	5	5500.2647.06
30	Medizinal (M5)	Schraubanschluss M4	Q	I	0.005	1	1.8	-	450g	QE	5	5500.2657.06
60	Medizinal (M80)	Schraubanschluss M6	P	I	0.08	1	7.2	-	1220g	QF	1	5500.2648.09
60	Medizinal (M80)	Schraubanschluss M6	Q	I	0.08	1	7.2	-	1220g	QF	1	5500.2658.09
1	Medizinal (M80)	QC 6.3 x 0.8 mm	N	I	0.08	475	1	-	72g	PG	15	5500.2630.07
1	Medizinal (M80)	QC 6.3 x 0.8 mm	P	I	0.08	320	0.65	-	80g	QC	15	5500.2640.07
1	Medizinal (M80)	QC 6.3 x 0.8 mm	Q	I	0.08	320	0.65	-	66g	PG	15	5500.2650.07
3	Medizinal (M80)	QC 6.3 x 0.8 mm	N	I	0.08	83	1.5	-	104g	PH	15	5500.2631.07
3	Medizinal (M80)	QC 6.3 x 0.8 mm	P	I	0.08	36	0.65	-	81g	QC	15	5500.2641.07
3	Medizinal (M80)	QC 6.3 x 0.8 mm	Q	I	0.08	36	0.65	-	70g	PG	15	5500.2651.07
4	Medizinal (M80)	QC 6.3 x 0.8 mm	N	I	0.08	53	1.7	-	108g	PH	15	5500.2632.07
6	Medizinal (M80)	QC 6.3 x 0.8 mm	N	I	0.08	32.5	2.4	-	109g	PH	15	5500.2633.07

Nennstrom	Filter-Typ	Klemme	Design	Schutzklasse	Ableitstrom	Ri	Verlustleistung	Überspannungsschutz	Gewicht	Gehäuse	Verpackung	Bestell-Nummer
[A]					[mA]	[mΩ]	[W]		[g]		[ST]	
6	Medizinal (M80)	QC 6.3 x 0.8 mm	P	I	0.08	12	0.86	-	80 g	QC	15	5500.2642.07
6	Medizinal (M80)	QC 6.3 x 0.8 mm	Q	I	0.08	12	0.86	-	100 g	PG	15	5500.2652.07
8	Medizinal (M80)	QC 6.3 x 0.8 mm	N	I	0.08	29.2	3.8	-	190 g	PI	10	5500.2634.07
10	Medizinal (M80)	QC 6.3 x 0.8 mm	N	I	0.08	22.8	4.6	-	200 g	PI	10	5500.2635.07
10	Medizinal (M80)	QC 6.3 x 0.8 mm	P	I	0.08	5	1	-	87 g	QC	15	5500.2643.07
10	Medizinal (M80)	QC 6.3 x 0.8 mm	Q	I	0.08	5	1	-	90 g	QC	15	5500.2653.07
12	Medizinal (M80)	QC 6.3 x 0.8 mm	N	I	0.08	13.2	3.8	-	201 g	PI	10	5500.2636.07
12	Medizinal (M80)	QC 6.3 x 0.8 mm	P	I	0.08	4	1.2	-	92 g	QC	15	5500.2644.07
12	Medizinal (M80)	QC 6.3 x 0.8 mm	Q	I	0.08	4	1.2	-	90 g	QC	15	5500.2654.07
16	Medizinal (M80)	QC 6.3 x 0.8 mm	N	I	0.08	7.2	3.7	-	308 g	PK	10	5500.2637.07
16	Medizinal (M80)	QC 6.3 x 0.8 mm	P	I	0.08	2	1	-	138 g	QD	15	5500.2645.07
16	Medizinal (M80)	QC 6.3 x 0.8 mm	Q	I	0.08	2	1	-	136 g	QD	15	5500.2655.07
20	Medizinal (M80)	QC 6.3 x 0.8 mm	N	I	0.08	6.0	4.8	-	322 g	PK	10	5500.2638.07
20	Medizinal (M80)	QC 6.3 x 0.8 mm	P	I	0.08	1.9	1.5	-	206 g	PI	10	5500.2646.07
20	Medizinal (M80)	QC 6.3 x 0.8 mm	Q	I	0.08	1.9	1.5	-	204 g	PI	10	5500.2656.07
30	Medizinal (M80)	Schraubanschluss M4	N	I	0.08	2.9	5.2	-	355 g	PK	10	5500.2639.09
30	Medizinal (M80)	Schraubanschluss M4	P	I	0.08	1	1.8	-	450 g	QE	5	5500.2647.09
30	Medizinal (M80)	Schraubanschluss M4	Q	I	0.08	1	1.8	-	450 g	QE	5	5500.2657.09
1	Medizinal (M5) HP	QC 6.3 x 0.8 mm	N	II	0.005	280	0.56	-	72 g	UL	15	3-134-830
1	Medizinal (M5) HP	QC 6.3 x 0.8 mm	N	I	0.005	286	0.57	-	72 g	PG	15	3-143-606
3	Medizinal (M5) HP	QC 6.3 x 0.8 mm	N	II	0.005	50	0.9	-	104 g	UM	15	3-134-831
3	Medizinal (M5) HP	QC 6.3 x 0.8 mm	N	I	0.005	55	0.99	-	104 g	PH	15	3-143-607
4	Medizinal (M5) HP	QC 6.3 x 0.8 mm	N	II	0.005	30	0.96	-	108 g	UM	15	3-134-832
4	Medizinal (M5) HP	QC 6.3 x 0.8 mm	N	I	0.005	33	1.06	-	108 g	PH	15	3-143-608
6	Medizinal (M5) HP	QC 6.3 x 0.8 mm	N	II	0.005	16.4	1.18	-	110 g	UM	15	3-134-833
6	Medizinal (M5) HP	QC 6.3 x 0.8 mm	N	I	0.005	20.5	1.48	-	109 g	PH	15	3-143-609
8	Medizinal (M5) HP	QC 6.3 x 0.8 mm	N	II	0.005	18.5	2.37	-	188 g	UN	10	3-134-834
8	Medizinal (M5) HP	QC 6.3 x 0.8 mm	N	I	0.005	21.6	2.76	-	190 g	PI	10	3-143-610
10	Medizinal (M5) HP	QC 6.3 x 0.8 mm	N	II	0.005	12.5	2.5	-	200 g	UN	10	3-134-835
10	Medizinal (M5) HP	QC 6.3 x 0.8 mm	N	I	0.005	15.5	3.1	-	200 g	PI	10	3-143-611
12	Medizinal (M5) HP	QC 6.3 x 0.8 mm	N	II	0.005	7.9	2.28	-	200 g	UN	10	3-134-836
12	Medizinal (M5) HP	QC 6.3 x 0.8 mm	N	I	0.005	11	3.17	-	201 g	PI	10	3-143-612
16	Medizinal (M5) HP	QC 6.3 x 0.8 mm	N	II	0.005	4.2	2.15	-	310 g	U0	10	3-134-837
16	Medizinal (M5) HP	QC 6.3 x 0.8 mm	N	I	0.005	6.9	3.53	-	308 g	UB	10	3-143-613
20	Medizinal (M5) HP	QC 6.3 x 0.8 mm	N	II	0.005	3.4	2.72	-	322 g	U0	10	3-134-838
20	Medizinal (M5) HP	QC 6.3 x 0.8 mm	N	I	0.005	6.2	4.96	-	322 g	PK	10	3-143-614
30	Medizinal (M5) HP	QC 6.3 x 0.8 mm	N	I	0.005	2.9	5.2	-	355 g	PK	10	3-143-615
1	Medizinal (M80) HP	QC 6.3 x 0.8 mm	N	I	0.08	286	0.57	-	72 g	PG	15	3-143-616
3	Medizinal (M80) HP	QC 6.3 x 0.8 mm	N	I	0.08	55	0.99	-	104 g	PH	15	3-143-617
4	Medizinal (M80) HP	QC 6.3 x 0.8 mm	N	I	0.08	33	1.06	-	108 g	PH	15	3-143-618
6	Medizinal (M80) HP	QC 6.3 x 0.8 mm	N	I	0.08	20.5	1.48	-	109 g	PH	15	3-143-619
8	Medizinal (M80) HP	QC 6.3 x 0.8 mm	N	I	0.08	21.6	2.76	-	190 g	PI	10	3-143-620
10	Medizinal (M80) HP	QC 6.3 x 0.8 mm	N	I	0.08	15.5	3.1	-	200 g	PI	10	3-143-621
12	Medizinal (M80) HP	QC 6.3 x 0.8 mm	N	I	0.08	11	3.17	-	201 g	PI	10	3-143-622
16	Medizinal (M80) HP	QC 6.3 x 0.8 mm	N	I	0.08	6.9	3.53	-	308 g	UB	10	3-143-623
20	Medizinal (M80) HP	QC 6.3 x 0.8 mm	N	I	0.08	6.2	4.96	-	322 g	PK	10	3-143-624
30	Medizinal (M80) HP	QC 6.3 x 0.8 mm	N	I	0.08	2.9	5.2	-	355 g	PK	10	3-143-625

Nennstrom	Filter-Typ	Klemme	Design	Schutzklasse	Ableitstrom	Ri	Verlustleistung	Überspannungsschutz	Gewicht	Gehäuse	Verpackung	Bestell-Nummer
[A]					[mA]	[mΩ]	[W]		[g]		[ST]	

Oft verkauft.

Sie können die Verfügbarkeit all unserer Produkte in Echtzeit prüfen: <https://www.schurter.com/de/info-center/support-tools/lagerbestand-distributor>

- 4 Designs N) Excellente symmetrische Dämpfungsgüte
- P) Hohe symmetrische Dämpfungsgüte
- Q) Standard Dämpfungsgüte
- HP) Hohe Performance

60A Medizinal Filter M5 und M80, Design P, sind nur geeignet für die Verwendung in Medizingeräten mit festem Anschluss ans Stromnetz.

Zubehör

Beschreibung



DIN_Rail_Kit
 Montagezubehör für kompakte 1- und 3-Phasen-Filter