

SCHURTER Smart Connector DS11



See below:  
[Approvals and Compliances](#)

**Description**

- Smart IEC Appliance Inlet C14 with WiFi
- Panel mount, Snap-in version from front side
- Unique mounting variant
- Compact design

**Unique Selling Proposition**

- First of its kind on the market
- Bi-directional connection from the cloud
- Device connection via WiFi
- Compatible with V-Lock cord retention

**Characteristics**

- WiFi 802.11b/g/n or Bluetooth 4.2 connectivity
- Relay switchable via WiFi (Cloud)
- Integrated energy live measurement with update rate up to 60 sec.
- Low standby Energy consumption (<0.5W)
- Button with RGB backlight
- Smartphone App for easy configuration, control and monitoring (iOS and Android)
- Smart API for direct data transfer to your own cloud

**Weblinks**

[pdf data sheet](#), [html datasheet](#), [General Product Information](#), [Approvals](#), [Distributor-Stock-Check](#), [Accessories](#), [Detailed request for product](#), [Dashboard](#)

**Technical Data**

**Electrical Properties**

Ratings IEC	10A / 250VAC; 50Hz
Energy Consumption (Standby)	< 0.5 W
Appliance Inlet	C14 acc. to IEC 60320-1 (for cold conditions) pin-temperature 70 °C, 10A, Protection Class I

**Mechanical Properties**

IP-Protection	IP40
---------------	------

**Measurement Properties**

Active Energy Metering Error	±0.2% full range
Reactive Energy Metering Error	±0.4% full range
Minimum measurable Current	20 mA

**Connectivity**

Wireless LAN	WiFi 802.11b/g/n
Bluetooth	Bluetooth 4.2 BLE

**Cloud Connectivity**

Data stored per device	Online-State
	Time last seen
	Voltage
	Current
	Power
	Accumulated Energy
	Power Factor
	Frequency
	State of AC output
	SSID of the connected network
Data stored per user	Name of the device
	Paired user accounts including device owner
	Username / Password (encrypted)
	E-Mail address
	Subscription information

**SCHURTER Smart Services**

SCHURTER Smart Dashboard	Web-based dashboard for device monitoring, management and control
SCHURTER Smart App	Smartphone app for Apple and Android devices. The smartphone app allows to easily configure the WiFi credentials on the SCHURTER Smart Connector DS11 and interface with the SCHURTER Smart Ecosystem
SCHURTER Smart API	HTTP REST API with user based authentication. The REST API can be used to interface directly with the SCHURTER Cloud via HTTPS and dedicated GET/POST/PUT/DELETE endpoints

**Approvals and Compliances**

Detailed information on product approvals, code requirements, usage instructions and detailed test conditions can be looked up in [Details about Approvals](#)

SCHURTER products are designed for use in industrial environments. They have approvals from independent testing bodies according to national and international standards. Products with specific characteristics and requirements such as required in the automotive sector according to IATF 16949, medical technology according to ISO 13485 or in the aerospace industry can be offered exclusively with customer-specific, individual agreements by SCHURTER.

## Approvals

The approval mark is used by the testing authorities to certify compliance with the safety requirements placed on electronic products.

Approval Reference Type: DS11

Approval Logo	Certificates	Certification Body	Description
	<a href="#">VDE Approvals</a>	VDE	VDE Certificate Number: 40056685





## Product standards

Product standards that are referenced

Organization	Design	Standard	Description
	Designed according to	IEC 60320-1	Appliance couplers for household and similar general purposes

## Compliances

The product complies with following Guide Lines

Identification	Details	Initiator	Description
	<a href="#">CE declaration of conformity</a>	SCHURTER AG	The CE marking declares that the product complies with the applicable requirements laid down in the harmonisation of Community legislation on its affixing in accordance with EU Regulation 765/2008.
	<a href="#">UKCA declaration of conformity</a>	SCHURTER AG	The UKCA marking declares that the product complies with the applicable requirements laid down in the British Amendment of Regulation (EC) 765/2008.
	RoHS	SCHURTER AG	Directive RoHS 2011/65/EU, Amendment (EU) 2015/863
	REACH	SCHURTER AG	On 1 June 2007, Regulation (EC) No 1907/2006 on the Registration, Evaluation, Authorization and Restriction of Chemicals 1 (abbreviated as "REACH") entered into force.
		SCHURTER AG	V-Lock system are based on a matching plug-dose combination. The connector is equipped with a notch intended for use with the latching cordset. The cord latching system prevents against accidental removal of the cordset.

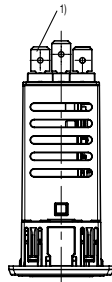
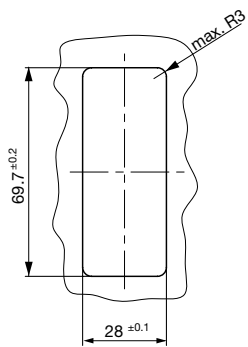
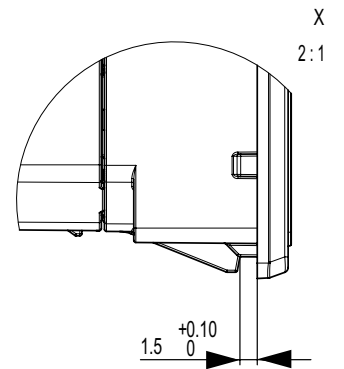
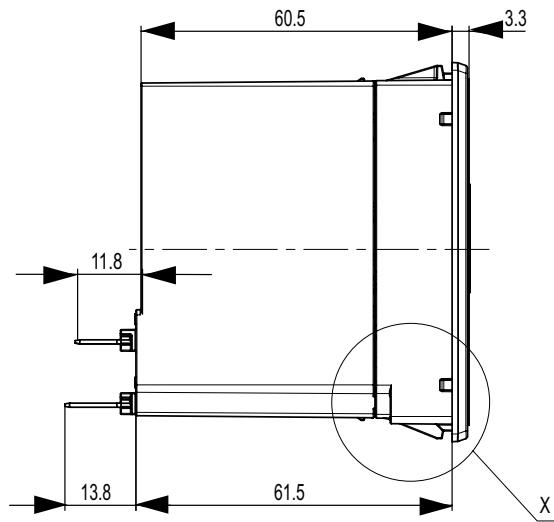
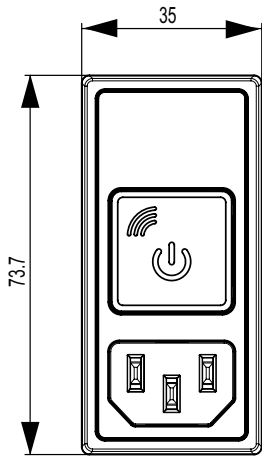

Dimensions [mm]



Panel cut-out

1) 3 x Quick connect 6.3 x 0.8 mm

D	S	1	1	-	1	1	-	00	00	-	15	04	-	0	2	-	01	01	01
					1	2		3	4		5	6		7	8		9	10	11

<b>Switching Element</b>																					<b>1</b>	
Relay	=																					
<b>Switch</b>																						<b>2</b>
With	=																					
<b>Color Housing with Switch</b>																						<b>3</b>
Black	=																					
<b>Color Housing without Switch</b>																						<b>4</b>
Black	=																					
<b>Appliance Inlet</b>																						<b>5</b>
C14	=																					
<b>Rated Current</b>																						<b>6</b>
10 A	=																					
<b>Device Interface</b>																						<b>7</b>
None	=																					
Isolated	=																					
<b>Mounting</b>																						<b>8</b>
Snap-in 1.5 mm	=																					
<b>Terminal PE</b>																						<b>9</b>
QC 6.3 x 0.8	=																					
<b>Terminal N</b>																						<b>10</b>
QC 6.3 x 0.8	=																					
<b>Terminal L</b>																						<b>11</b>
QC 6.3 x 0.8	=																					

**Variants**

Rated Current [A]	Protection Class	Serial device in- terface	Mounting	IP-Protection	Config. Code	Order Number
10	I	None	Snap-in	IP40	DS11-11-0000-1504-02-010101	3-137-412

Most Popular.

Availability for all products can be searched real-time: <https://www.schurter.com/en/Stock-Check/Stock-Check-SCHURTER>

**Packaging unit** 10 Pcs

**Mating Outlets/Connectors shuttered**

Category / Description



[Connector Overview complete](#)

4783 Mounting: Power Cord, 3 x 1 mm<sup>2</sup> / 3 x 18 AWG, Cable, Connector: IEC C13 4783



[Power Cord Overview complete](#)

VAC13KS, Overview, V-Lock cord retaining, diverse Connector IEC C13, diverse, black VAC13KS